

**1/10TH SCALE
ELECTRIC OFF-ROAD
BUGGY / SHORT COURSE /
TRUGGY / MONSTER TRUCK**

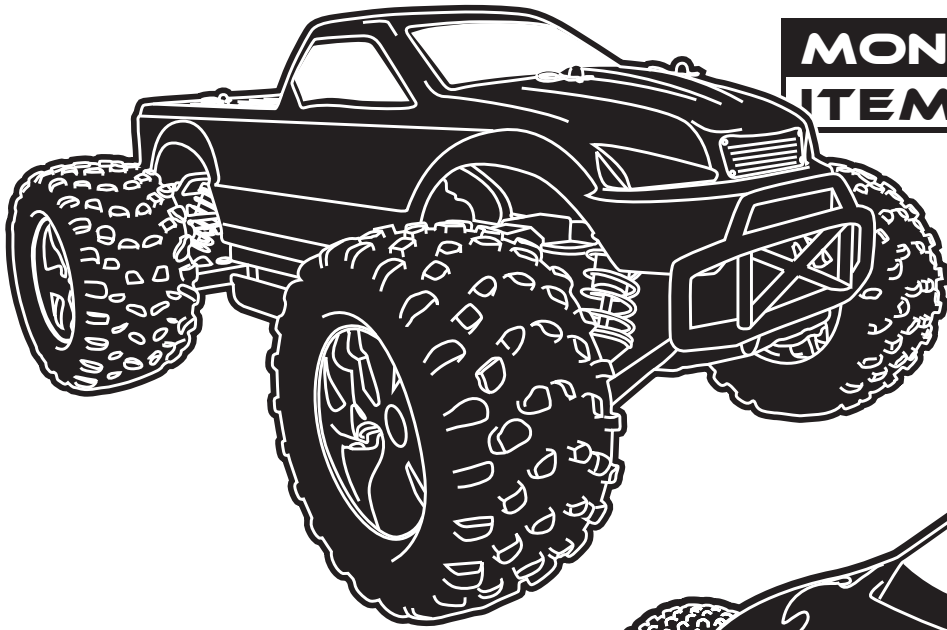

**MONSTER TRUCK
ITEM NO.E10MT**

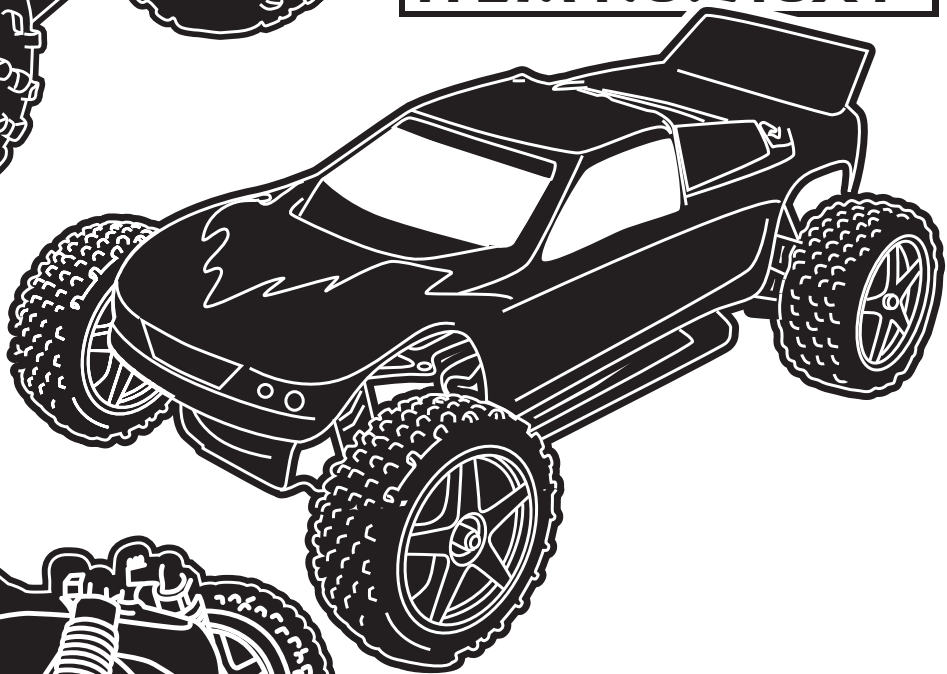

**TRUGGY
ITEM NO.E10XT**

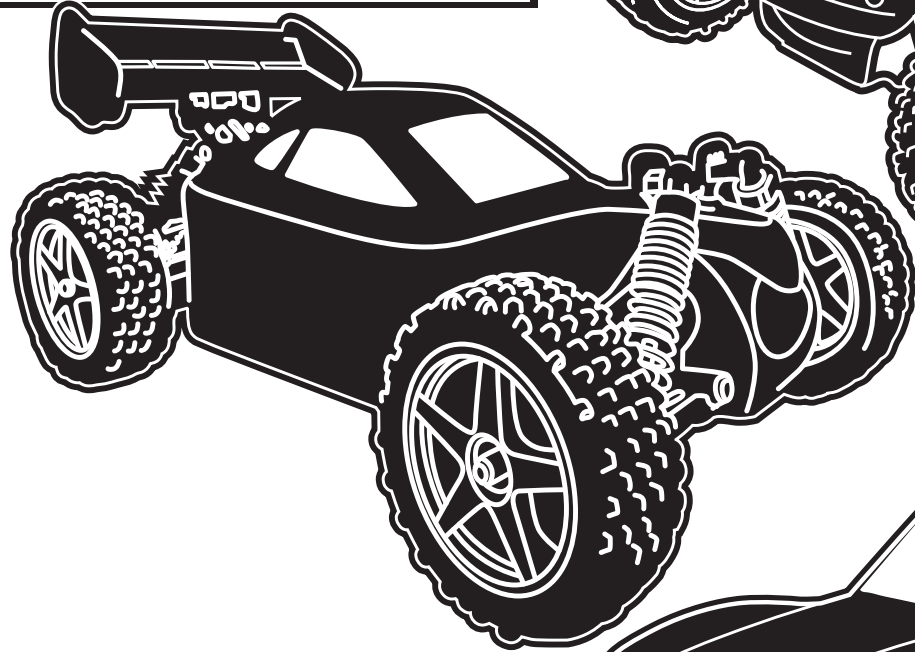

**BUGGY
ITEM NO.E10XB**

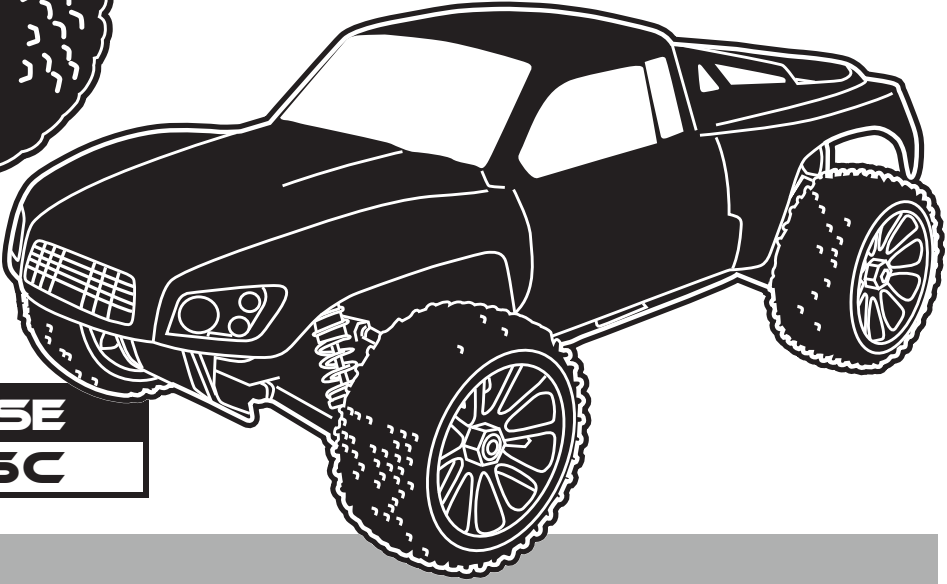

**SHORT COURSE
ITEM NO.E10SC**

Before You Start Assembling

Thank you for purchasing our Ready To Run 1/10 scale electric off-road vehicle. This manual contains the basic methods of operation, assembly details, and related accessories. Operators less than 14 years of age need to be supervised by an adult. Please read all information in this manual before operation to avoid any damage or danger.

All operating instructions should be read before the use of this product. It contains important information for future reference. In addition, because we constantly update our products, some small physical features may change. Check our website for any update on changes.

Tools Needed

2.5 2.0 1.5 Allen key

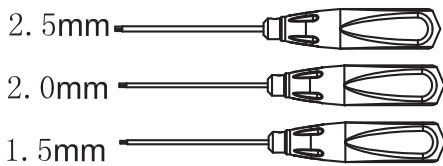

5.5 7 Wrench

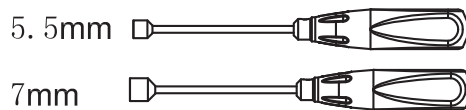

Cross Wrench(big)

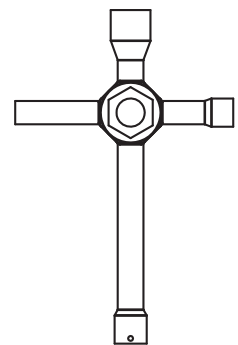

Needle Nose Plier

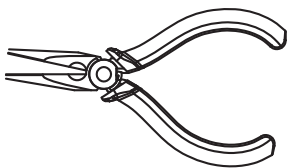

Hobby Scissors

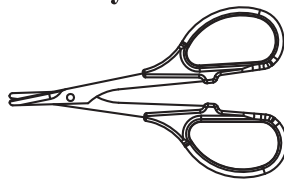

Cross Wrench(small)

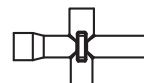

5.5mm Open end wrench

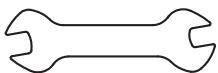

Charger

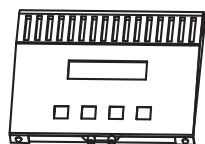

Reamer



Apply CA glue



Grease



1.2V AA Battery



Silicone Oil



Safety Precautions

This is a high-quality radio control model. Pay attention at all times to insure careful operation. If care is not taken, loss of life and property may result. Children should not be allowed to operate in the absence of adult supervision. Operational errors, or the incorrect use of this product and important information included in this manual (which may result in the loss of life, severe injury or property damage), will be the responsibility of the owner.

-----This model is controlled by radio signals, which may be subject to outside interference beyond the control of vehicles radio system.

-----Therefore, keep within a safe distance to avoid accidents and away from motor vehicles and people.

-----Do not place or run on wet grass or in puddles because electronic equipment (servers, receivers and power transfer) is not waterproof. If you want to run in these areas the electronics must be waterproofed.

-----Do not drive if battery power is low!

-----Do not drive in poor conditions or vehicle damage may occur.

-----Be careful to comply with the instructions and warnings of other equipment used (charger and battery, etc.).

-----Put chemicals, metals, and electronic equipment out of the reach of children.

-----Only careful and cautious use of remote control cars can protect life and property from harm.

Warranties

Ask retailers for replacement or return for manufacturing defective or missing parts. There is no warranty against wear and tear caused by incorrect operation or use of incorrect parts.

Retailers are to provide technical assistance free of charge for beginners.

Operational Requirements

First, make sure batteries are fully charged. Check all connections and settings .

Install 8AA batteries in the remote, ensure that the batteries have full power, pay attention to positive and negative polarity, and do not install in the wrong direction.

The remote control system has a variety of different functions and settings. Before initial use, ensure that all functions and settings have been fully understood.

2.4GHZ RADIO SYSTEM HTX-242



Install the batteries

- (1) Remove the battery compartment cover.
- (2) Replace the used batteries with new AA size batteries.

Please replace batteries when the power indicator blinks or the buzzer beeps.

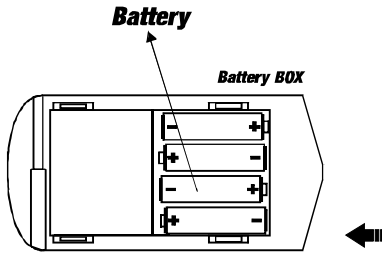

TRANSMITTER DIAGRAM

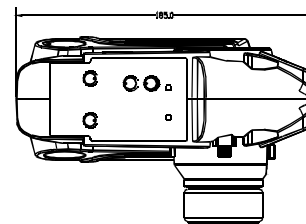
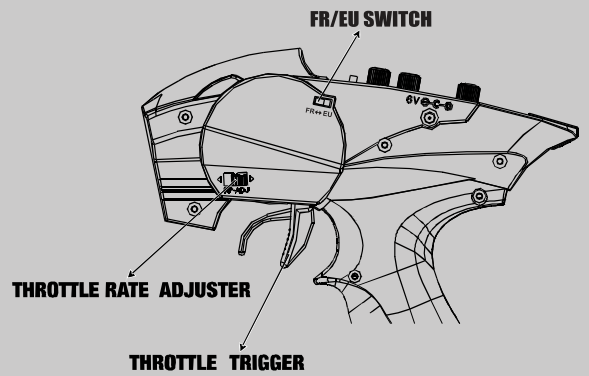

Transmitter Size

HTX-RX

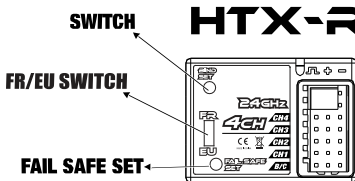

Connectors

- 1: Steering servo (CH1)
- 2: Throttle servo (CH2)
- 3: CH3 servo (CH3)
- 4: CH4 servo (CH4)
- B/C: Power connector

Receiver Size

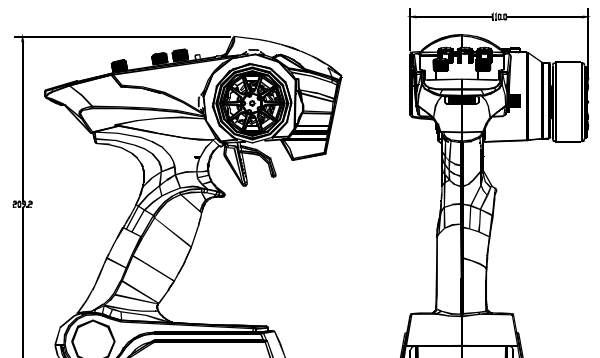
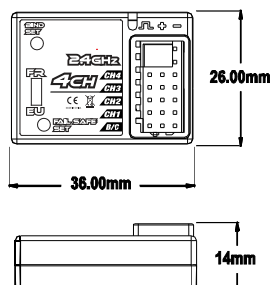

Transmitter Adjustment

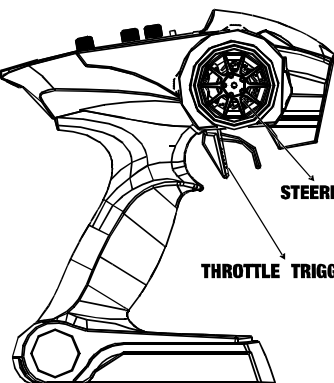

A. Throttle Trigger

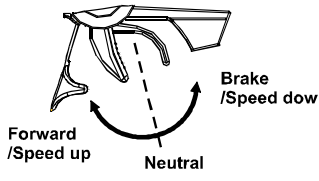

1. Push the trigger forward to slow down or brake.
2. Pull the trigger backward to accelerate.

Throttle Trim: Position the throttle trigger at the neutral position, adjust the throttle trim accordingly.

Steering Trim: If the front wheel does not align straight, use the steering trim to make adjustment.

B. Steering Wheel

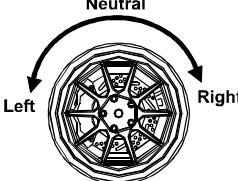

Turn the steering wheel counterclockwise to turn left, turn the steering wheel clockwise to turn right.

2.4GHz



Position the transmitter and receiver 40cm apart when operating.

Low Battery Alarm

Do not operate the radio system when the battery power is low.

Fail Safe Function Setting

1. Set the TH, ST switches to the normal position.
2. Turn on the transmitter and receiver.
3. Press the F/S SET button, the LED on the receiver should start flashing rapidly.
4. Put the throttle trigger at the brake position, press the F/S SET button, the LED should become solid.
5. For electric model, put the throttle trigger at the stop position when you are making the setting.

Binding the transmitter and receiver

- 

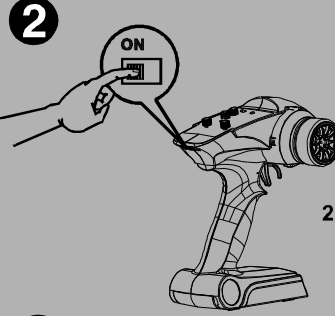
1. turn on the receiver power. Press the SW switch. The receiver's LED should start flashing.
- 

2. Turn on the transmitter.
- 

3. When the LED on the receiver becomes solid, the binding process is completed.

Receiver and servo connection

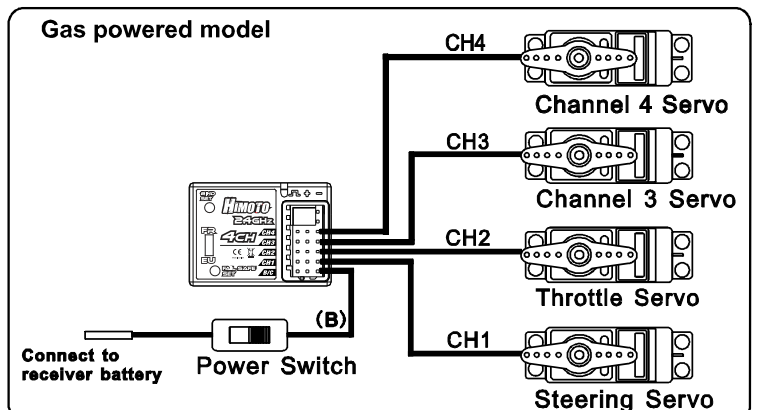
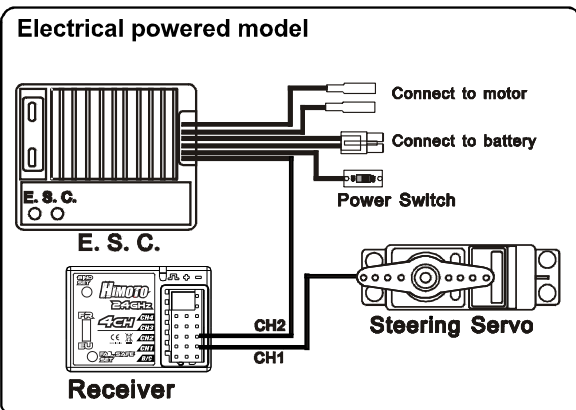

Operation Check List

1. Install fresh, new batteries into the transmitter and vehicle. Verify all the control functions are working properly.
2. Verify steering is set to the neutral position, the front wheels of the vehicle should point straight forward when the steering wheel on the transmitter is centered.
3. The ESC on the vehicle is pre-configured at the factory. When you turn on the transmitter and vehicle, you should hear a beep in 1-2 seconds and the indicator light should be lit.
4. With the battery fully charged, the run time for the vehicle is around 7 to 15 minutes depends on the condition of the running environment. Please stop operation when the battery show sign of low power.

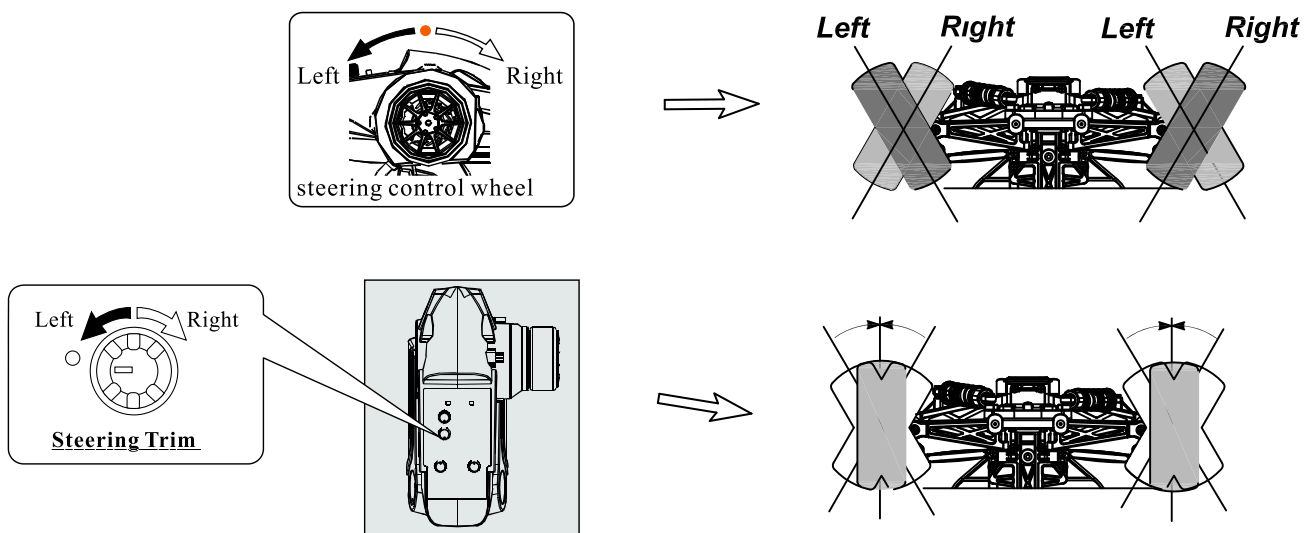

Common Troubleshooting

Problem: Motor is not working

Causes: A broken motor coil, battery capacity is inadequate or not charged, remote control not turned on or esc switch not turned on.

Solution: Replace motor, change batteries, turn switches on

Problem: Poor motor performance

Causes: Battery power is low, ESC (Electric speed control) is not adjusted properly, drive train loosened.

Solution: Replace or recharge the battery. When you first turn on the car, don't touch throttle trigger until all noise stop. Check that the gear mesh is not too tight or loose.

Problem: Difficult to steer the car

Causes: Transmitter or receiver battery are low, steering servo trim not set correctly

Solution: Replace or recharge the battery; when car is not moving, manually set steering trim so that the wheels are pointed forward.

Service and Maintenance

In order not to void car warranty, always keep your buggy clean. In areas of high dust and dirt, be sure to blow off dirt and dust with a compressor, soft bristle brush, or toothbrush.

Always check car for loose or broken parts and replace before and after running.

Regularly check screws to make sure that they are tight.

Replacement parts are available at many local retailers or online stores. Feel free to contact retailers for help in replacing parts.

SPECIFICATIONS

Model	Code	Length	Width	Height	Wheelbase	Wheel Dia.	Wheel Width	Gear Ratio
BUGGY	E10XB	409mm	256mm	139mm	288mm	85mm	254mm	9.6
MONSTER TRUCK	E10MT	422mm	335mm	163mm	296mm	116mm	332mm	11.7
TRUGGY	E10XT	432mm	330mm	144mm	296mm	106mm	329mm	10.9
SHORT COURSE	E10SC	453mm	256mm	144mm	288mm	90mm	254mm	10.2

Explode Diagram of the Buggy

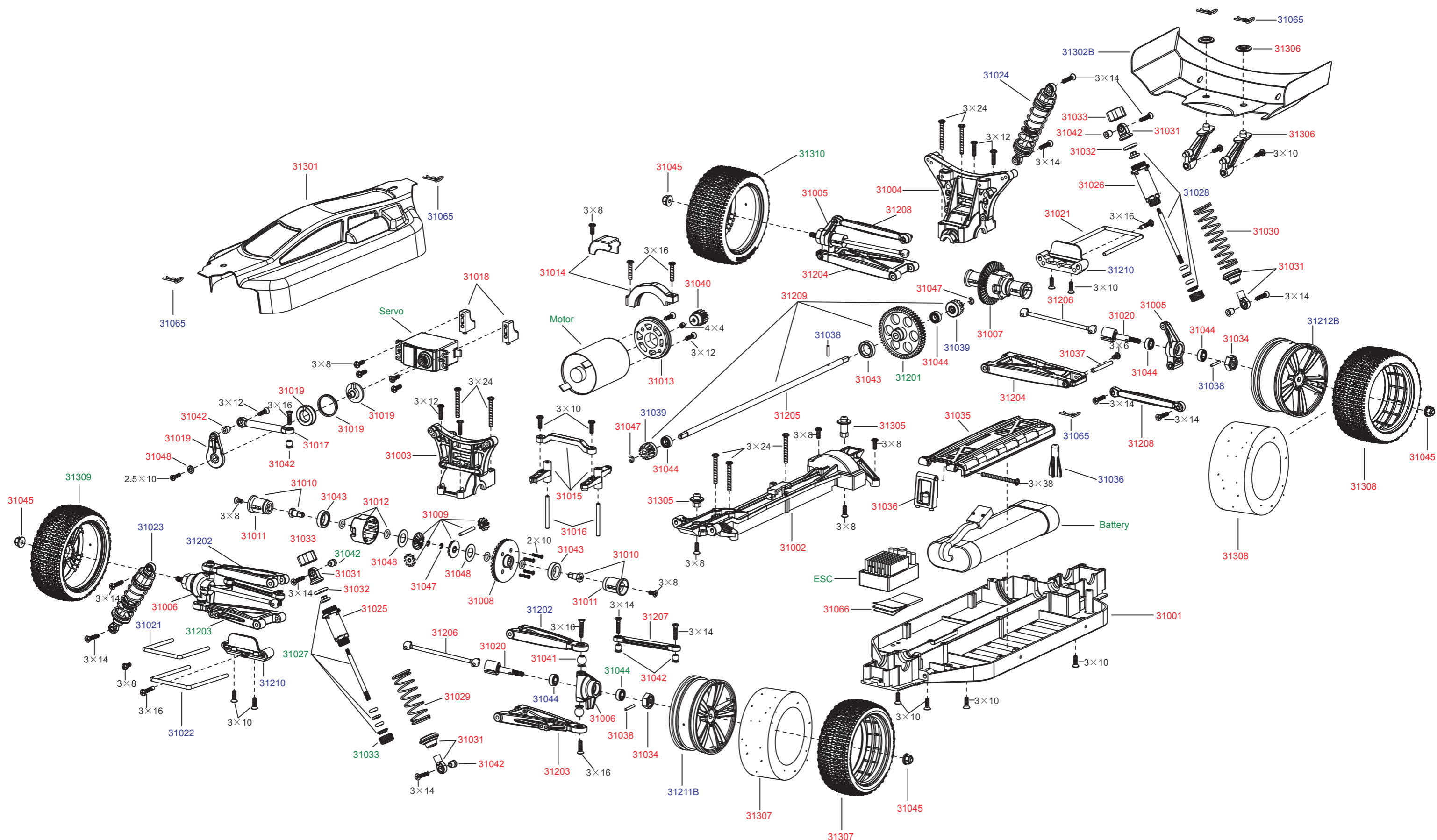

Explode Diagram of the Short Course Truck

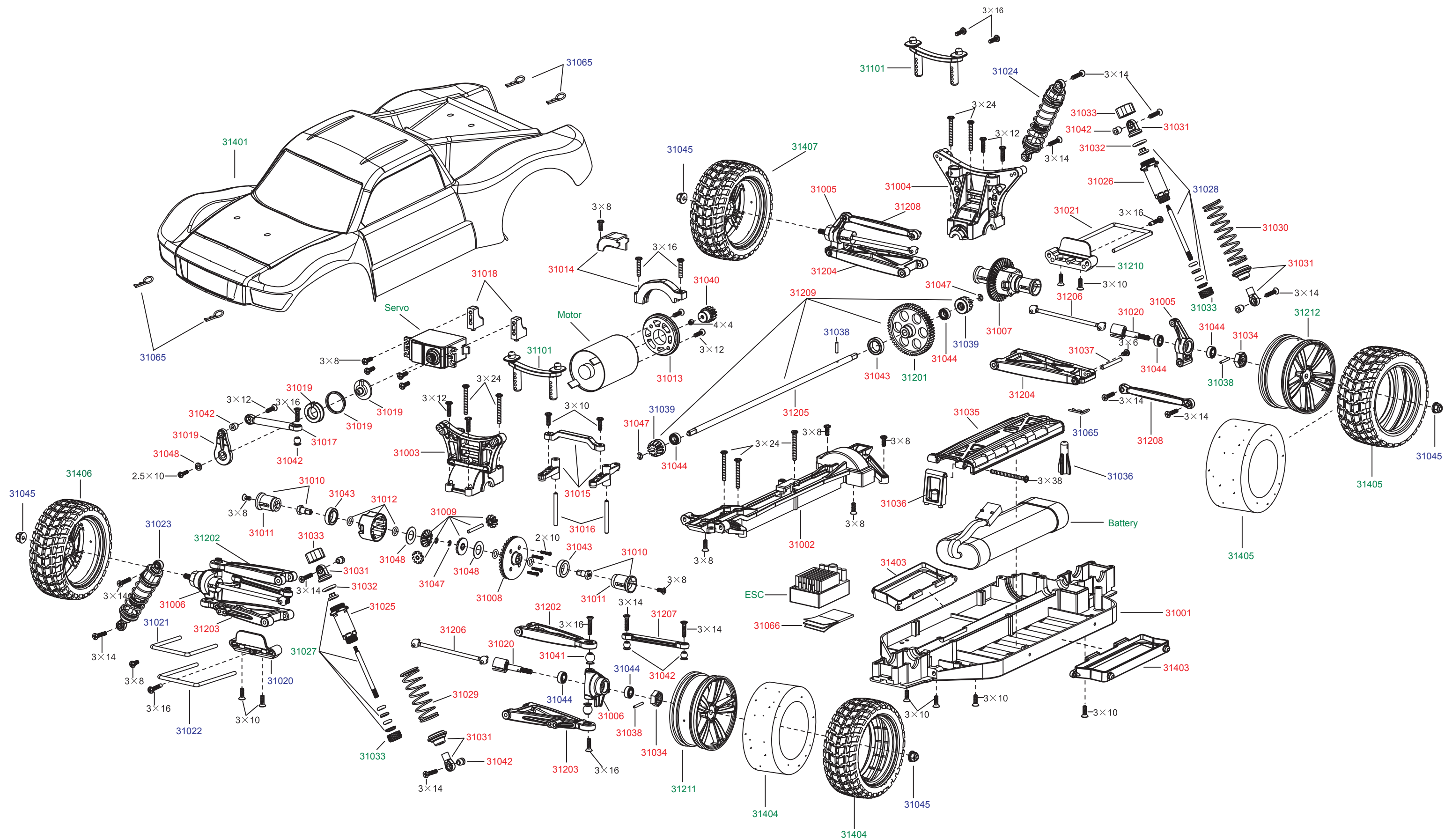

Explode Diagram of the Truggy

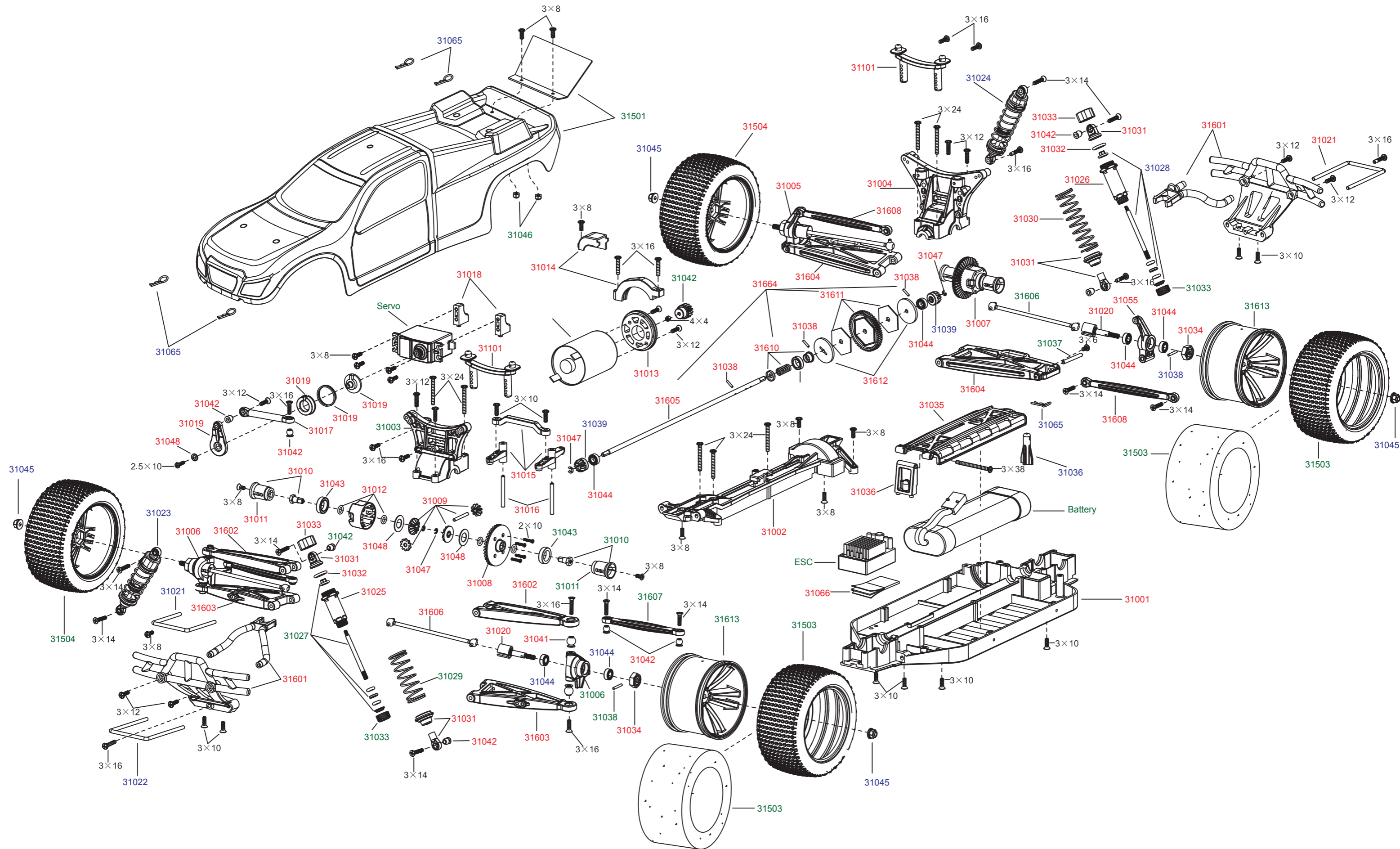

STANDARD PARTS LIST

31001

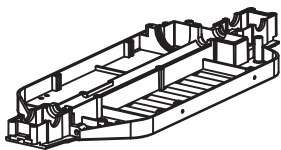

Chassis

31002

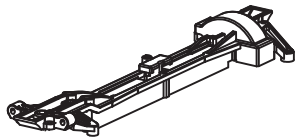

Upper Deck

31003



Front Shock Tower

31004

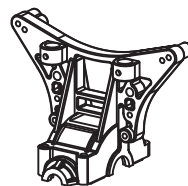

Rear Shock Tower

31005

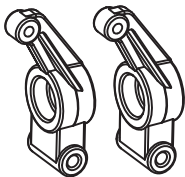

Rear Hub

31006

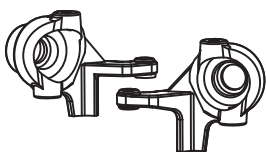

Knuckle Arms

31007

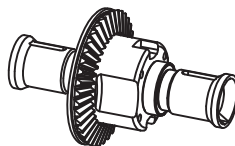

F/R Differential Gear

31008



Differential Crown Gear 38T and Sealing

31009

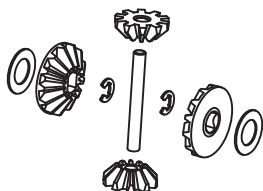

Differential Bevel Gear

31010

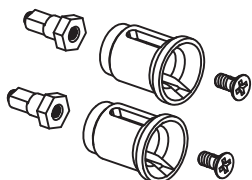

Differential Outdrives Gear

31011

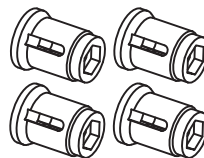

Differential Outdrives

31012

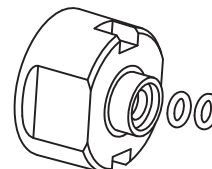

Differential Case and Sealing

31013



Motor Mount

31014

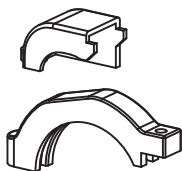

Motor Support Mount

31015

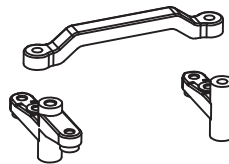

Front Servo Saver Arm

31016

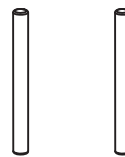

Steering Shaft

31017

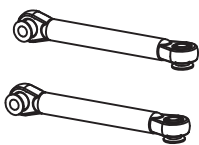

Servo Steering Linkage

31018

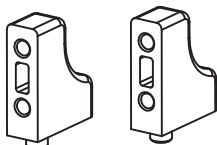

Servo Mounts

31019

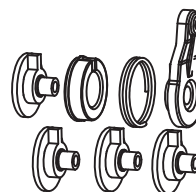

Servo Savers

31020

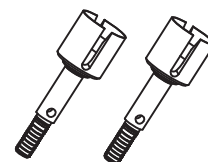

Wheel Axle

31021

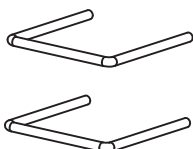

Upper Hinge Pin

31022

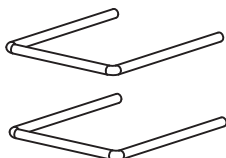

Lower Hinge Pin

31023



Front Shock Absorber

31024

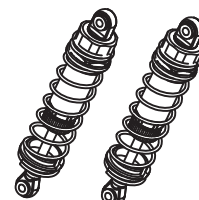

Rear Shock Absorbers

STANDARD PARTS LIST

31025

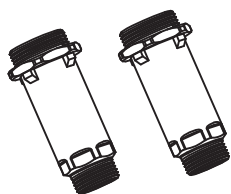

Front Shock Housing

31026

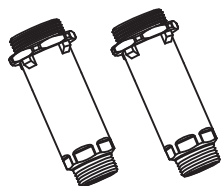

Rear Shock Housing

31027

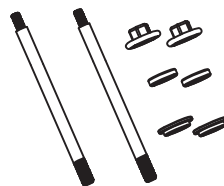

Front Shock Shaft

31028

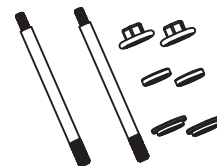

Rear Shock Shaft

31029



Front Shock Absorber Springs

31030



Rear Shock Absorber Springs

31031



Upper/Lower Shock End

31032



Shock Sealing

31033

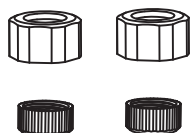

Shock Caps

31034

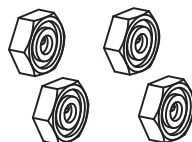

Wheel Nuts

31035

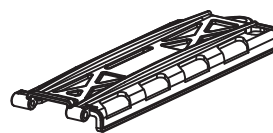

Battery Tray

31036

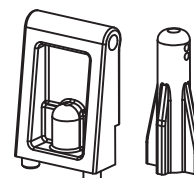

Battery Posts

31037

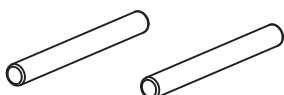

Lower Hinge Pin

31038

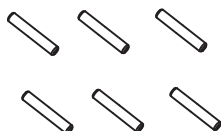

Pins 2X10

31039

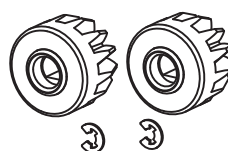

Differential Pinion Gear

31040

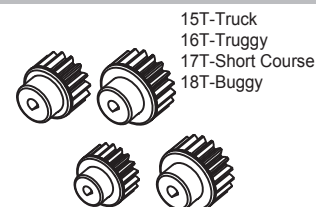

Pinion Gears 15T,16T,17T,18T

31041



Ball Head (8.0mm)

31042



Ball Head (5.80mm)

31043

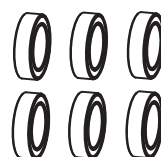

Ball Bearings 15X10X4

31044

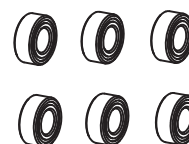

Ball Bearings 10X5X4

31045



Lock Nuts M4

31046



Lock Nuts M3

31047



E-Clips 2.5

31048



Shims 7.9X3.3X0.5

STANDARD PARTS LIST

31049



Button Head Screws 2X10

31050

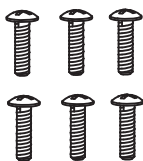

Button Head Screws 2.5X10

31051

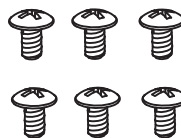

Button Head Screws 3X6

31052

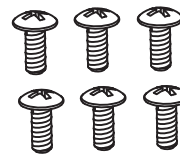

Button Head Screws 3X8

31053

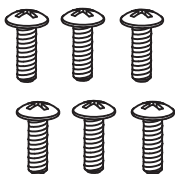

Button Head Screws 3X10

31054

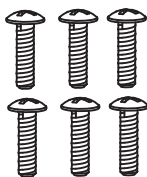

Button Head Screws 3X12

31055



Button Head Screws 3X16

31056



Button Head Screws 3X26

31057

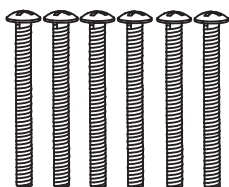

Button Head Screws 3X38

31058



Flat Head Screws 3X8

31059



Flat Head Screws 3X12

31060

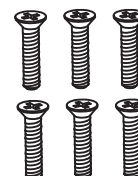

Flat Head Screws 3X14

31061



Flat Head Screws 3X16

31062

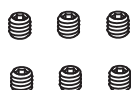

Grub Screws M3X3

31063

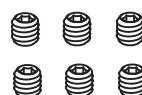

Grub Screws M4X4

31064



Plastic Cable Ties

31065



Body Clips

31066



Foam Double Side Tape

31067

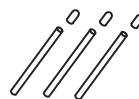

Antenna Pipe

31101

(Not Suitable for Buggy)

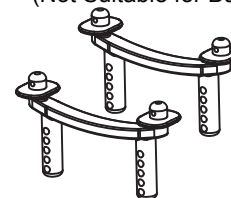

Body Mount for Trucks

31301

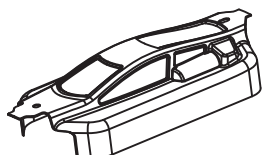

Buggy Body

31303

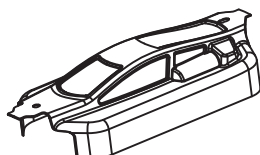

Transparent Buggy Body

31401

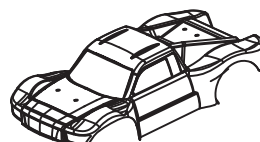

Short Course Body

31402

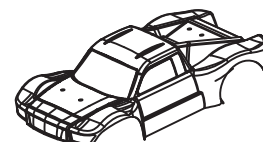

Transparent Short Course Body

SHORT COURSE, BUGGY

31201

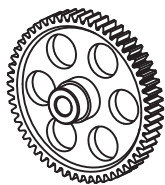

Main Gear 56T

31202

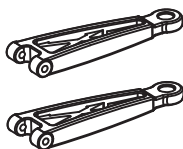

Front Upper Susp Arm

31203

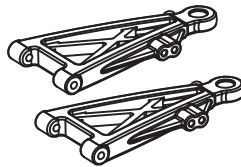

Front Lower Susp Arm

31204

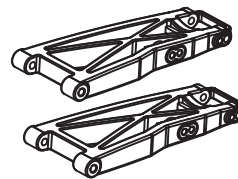

Rear Lower Susp Arm

31205



Alum Center Driveshaft

31206

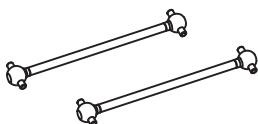

Dogbone (77.3mm)

31207

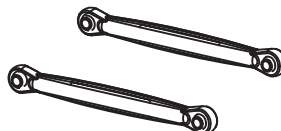

Steering Linkage

31208

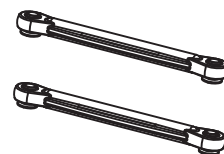

Rear Upper Linkage

31209



Center Driveshaft Complete with Gear

31210

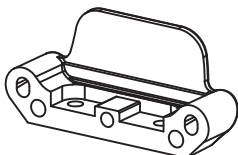

Susp Hinge Pin Holder

31211

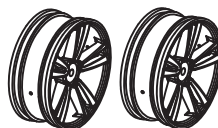

Front Wheel

31212

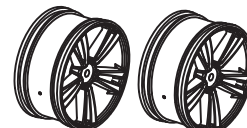

Rear Wheel

31307

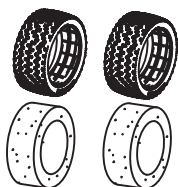

Buggy Front Tires

31308

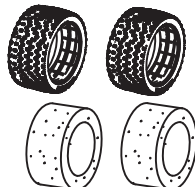

Buggy Rear Tires

31309

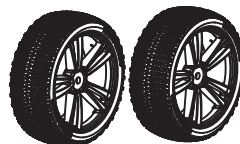

Front Tires and Rims For Buggy

31310

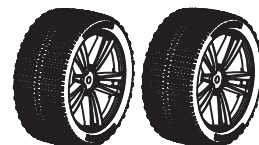

Rear Tires and Rims For Buggy

31404

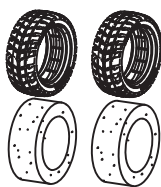

Front Tires for Short Course Truck

31405

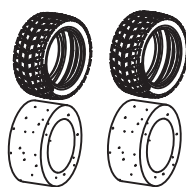

Rear Tires for Short Course Truck

31406



Front Tires and Rims for Short Course Truck

31407

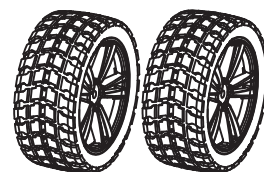

Rear Tires and Rims for Short Course Truck

31302



Wing for Buggy

31305

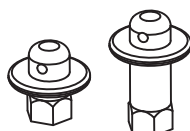

Buggy Body Mount

31306

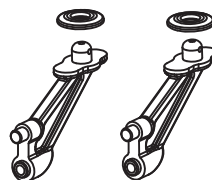

Buggy Wing Support

31403

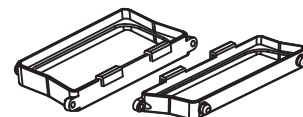

Side Body Mounts for Short Course Truck

TRUGGY, TRUCK

31601

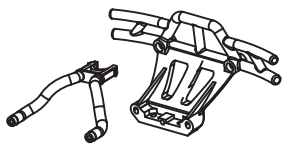

Bumper for Truggy and Truck

31602



Front Upper Susp Arm

31603

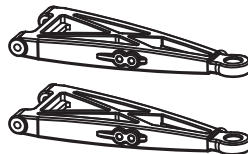

Front Lower Susp Arm

31604

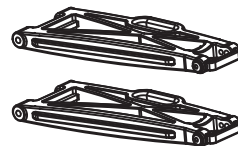

Rear Lower Susp Arm

31605



Alum Center Driveshaft

31606

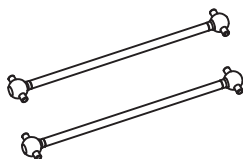

Dogbone (96.4mm)

31607



Steering Linkage

31608



Rear Upper Linkage

31609

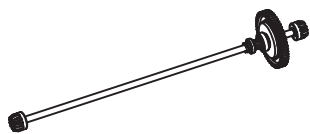

Slipper Clutch Complete with Gear

31610

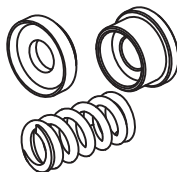

Spring Mount

31611

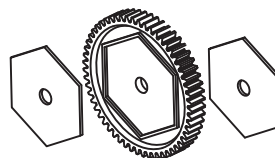

Main Gear 68T and Slipperpads

31612

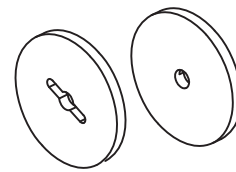

Slipper Plates

31801

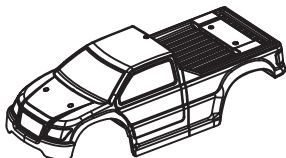

Truck Body

31802

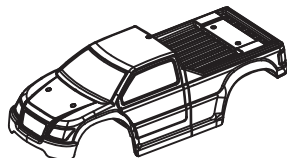

Transparent Truck Body

31501

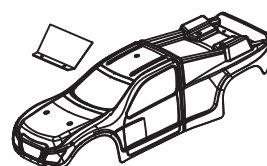

Truggy Body

31502

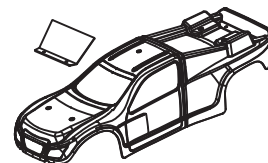

Transparent Truggy Body

31803

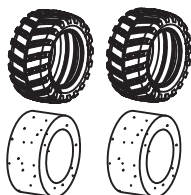

Tires for Truck

31804

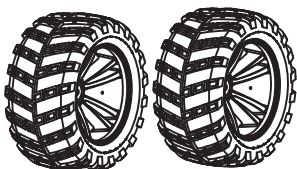

Tires and Wheels for Truck

31503

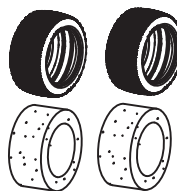

Tires for Truggy

31504

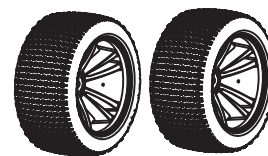

Tires and Wheels for Truggy

31613

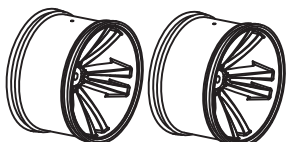

Wheels

OPTIONAL GEAR

11170

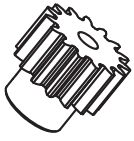

0.8 Module Motor Gear (15T)

11171



0.8 Module Motor Gear (16T)

11177

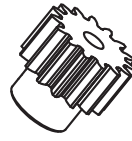

0.8 Module Motor Gear (17T)

11178



0.8 Module Motor Gear (18T)

ELECTRONICS

HTX-242T



Two Button 2.4 Ghz Radio

HTX-242

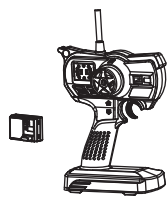

Two Button 2.4 Ghz Radio Set

HTX-RX

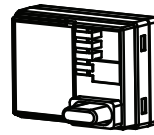

4channels 2.4G Receiver

HTX-241

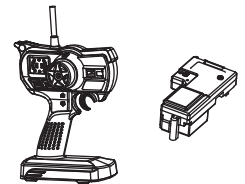

2.4 Ghz 2 in 1 Radio Set

03016

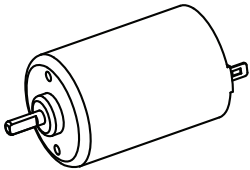

RC550 Motor

03018

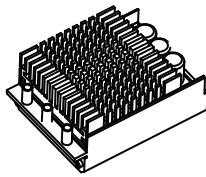

120A ESC

03014



Battery Pack (7.2V, 2000mAH)

HTX-241RE

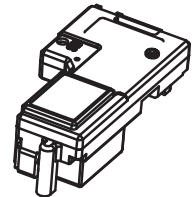

2 in 1 ESC / Receiver

SERVO3KG

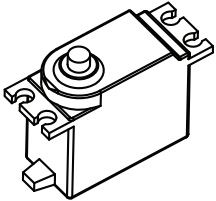

3Kg Servo Unit

SERVO6KG

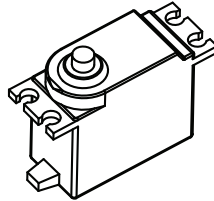

6Kg Servo Unit

2601



Power Connector For Banana Plug

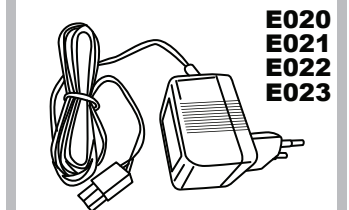

NI-MH Battery Charger

**E020
E021
E022
E023**

E199

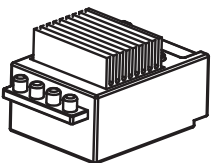

Brushless ESC

E028

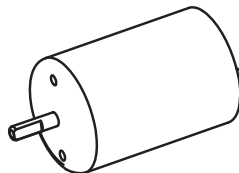

Brushless Motor

03019B



Battery Pack w/Banana Plug (7.2V,3000mAH)

LP2700



Li-Po Battery (11.1V 2700mAh 3S 30C)

E3US

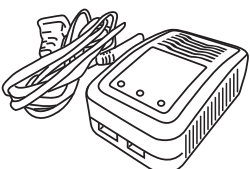

LiPo Balance Charger (America Standard)

E3EU

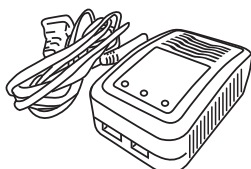

LiPo Balance Charger (Europe Standard)

E3EU

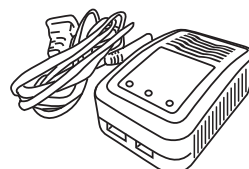

LiPo Balance Charger (Australia Standard)

E3UK

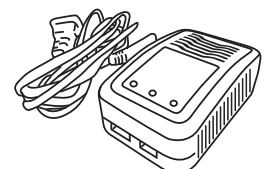

LiPo Balance Charger (UK Standard)

OPTIONAL STANDARD PARTS

33001

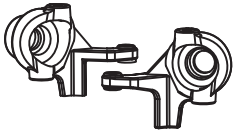

Alum Knuckle Arm

33002

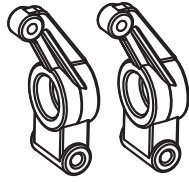

Alum Rear Hub

33003

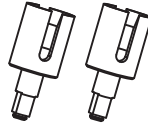

Alum Differential Outdrives

33004

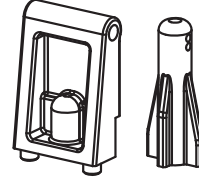

Alum Battery Posts

33009

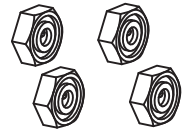

Alum Wheel Hub

33005



Alum Front Shock Absorber

33006

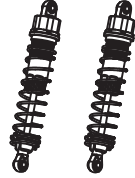

Alum Rear Shock Absorber

33007



Alum Motor Mount

33008

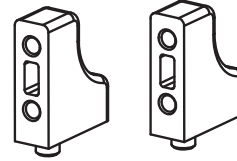

Alum Servo mounts

33101

(Not Suitable for Buggy)

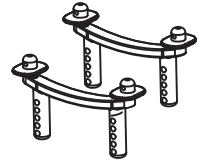

Alum Body Mount for Trucks

OPTIONAL PARTS SHORT COURSE, BUGGY

33201

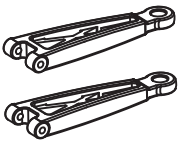

Alum Front Upper Susp Arm

33202

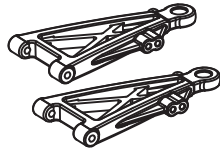

Alum Front Lower Susp Arm

33203

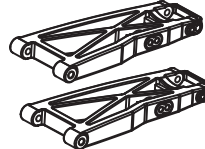

Alum Rear Lower Susp Arm

33204

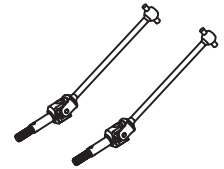

F/R Universal Shaft

33205

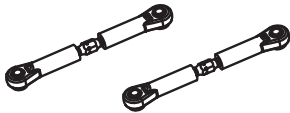

Alum Steering Linkage

33206

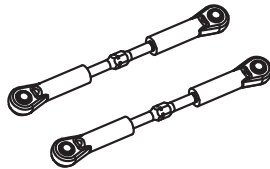

Alum Rear Upper Linkage

33301

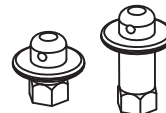

(Buggy only)

Alum Buggy Body Mount

OPTIONAL PARTS TRUGGY, TRUCK

33601



Alum Front Upper Susp Arm

33602

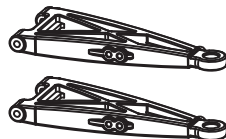

Alum Front Lower Susp Arm

33603



Alum Rear Lower Susp Arm

33604

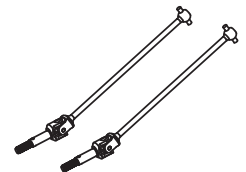

F/R Universal Shaft

33605

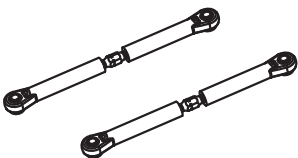

Alum Steering Linkage

33606

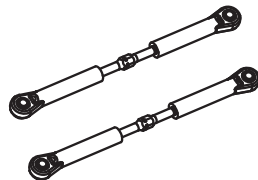

Alum Rear Upper Linkage

